

# Quick Installation Guide

## Focupix Premium Easy-Mounting Electric Motorized Screen

---

*Thank you for your purchase of our Premium Easy-Mounting Electric Screen. Our screen is your ideal solution for home theatre, conference room, classroom and other projection needs. This guide will walk you through the screen basics and the easy installation process.*

### 1. Screen components

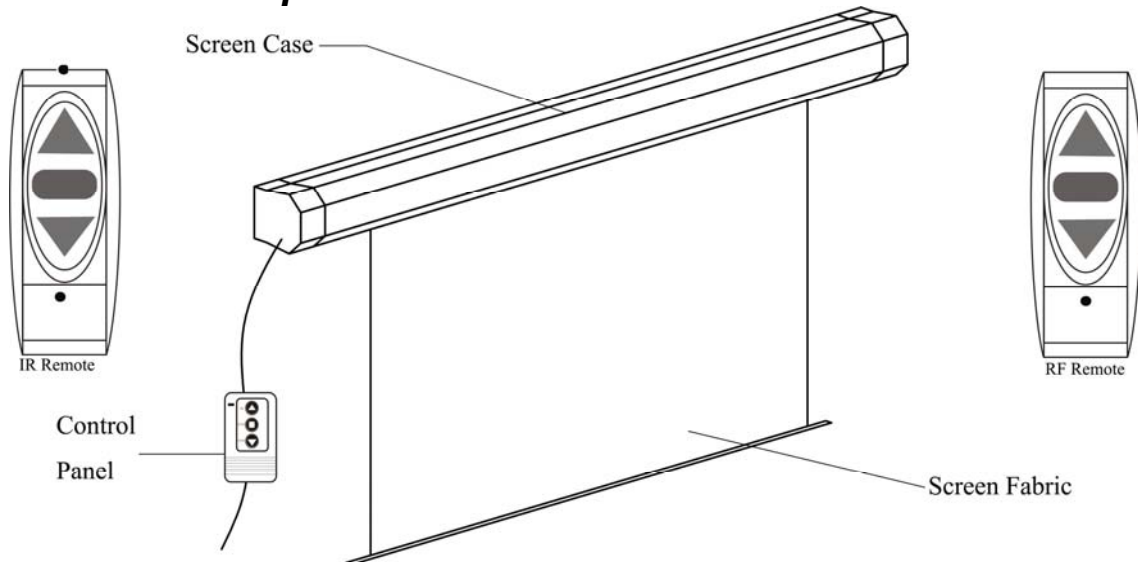

- Control panel is also the **remote receiver**.

How to distinguish between the IR and RF remote?

IR remote has 2 small LED light on the front, while the RF has 1 LED light.

### 2. Screen features

- Premium quality electric screen
- Enhanced gain for ultimate image enhancement
- 18-inch user adjustable drop
- Stylish, heavy duty metal screen case
- Easy-mounting design (no professional installation required)
- Long lasting, fire-resistant screen case and fabric
- Remote control provides ultimate convenience
- Premium Dual Remote: RF remote for long range control, and IR remote is ready to be integrated with universal home theater learning remote
- Advanced anti-static fabric processing prevents dust accumulation
- Cleanable screen surface

### 3. Screen installation

The screen can be installed in 3 different ways with common household tools.

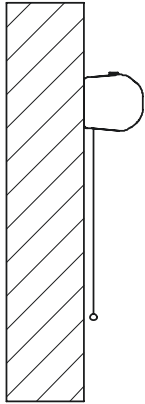

a) Wall mounting

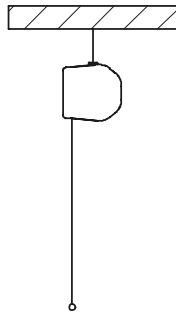

a) Ceiling mounting

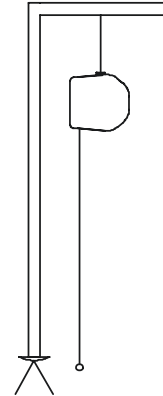

c) Rack mounting

- An optional bubble level is recommended for all installations.
- An optional stud-finder is recommended for wall and ceiling mounting.

### 4. Screen operations:

**Warning:** Operating the screen prior to properly mounting screen is prohibited. Such Operation can cause permanent damage to screen and motor. Such damages are not covered by warranty.

- 1) Operation: Please make sure the screen is mounted properly before operation. You can now easily operate your screen with the 3 buttons of the two remote controls (IR and RF dual remotes) or the remote receiver/control panel.
  - a) Press the “▲” button to pull down the screen, the screen will stop automatically when it is fully opened.
  - b) Press the “▼” button to roll back the screen, the screen will stop automatically when it is fully closed.
  - c) Press the “■” button to stop the screen at any position.

Note: When the screens is rolling back, if you want to pull it down again, you can press the “■” button and then press the “▼” button. Or you can also press the “▼” button twice.

- 2) Dual remote operation: Each of the projection screens can be controlled by the included dual remote system (IR or RF). Both remotes can be used to control the screen.
  - a) Replacing/adding remote control: If a remote control needs replacement, or you simply need to add one additional remote control, please first press and hold the stop key “■” on the **remote receiver** for 5 seconds, and then press any key on the new remote control, the new remote can now be used to control all screen features.
  - b) Disable remote control: If you want disable all remote controls, press and hold the stop key “■” in the remote receiver for 15 seconds. Then no remote control can control the projection screen. Use operation a) to enable remote control again.

## 5. User adjustable stop position: (Feature also known as “user adjustable drop”)

The screen *Top Limit* and *Bottom Limit* position can be adjusted using a regular Philips screwdriver, please see the illustration below

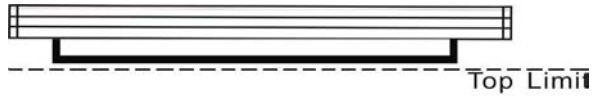

Top Limit is the stop line when using remote to fully close the screen.

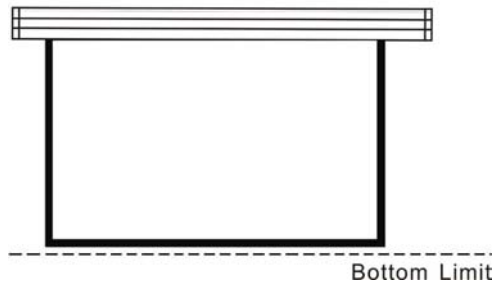

Bottom Limit is the stop line when using remote to fully open the screen.

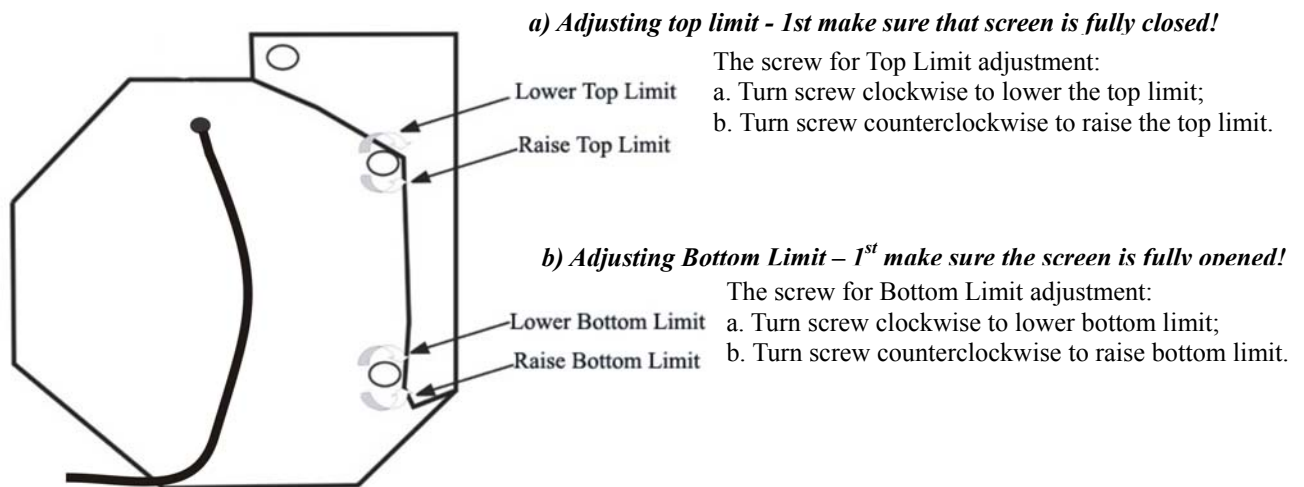

Trouble shooting:

- 1) If the screen is fully closed, but the screen can not stop rolling back action, please turn the Top Limit screw clockwise to restore stop position.
- 2) If the screen is fully opened, but the screen can not stop pulling down action, please turn the Bottom Limit screw counter-clockwise to restore stop position..

## 6. Power specification

110V 60Hz

## 7. Safety instructions

- **Warning:** Improper handling on electric cause damage and personal injury. If you do not feel comfortable performing installation or other operations related to screen product, consult a qualified professional.
- Please handle with care during transportation and installation. Seek professional help if are having problem in installation.
- Please do not fold the screen fabric. Keep screen surface away from sharp objects.
- Use only clear water and clean soft cloth for screen cleaning.
- Keep screen surface away from liquid, smog and chemical.
- Keep screen away from high temperature.
- Please store the screen in dry environment, be sure to clean the screen before storage.

## 8. Dimensions

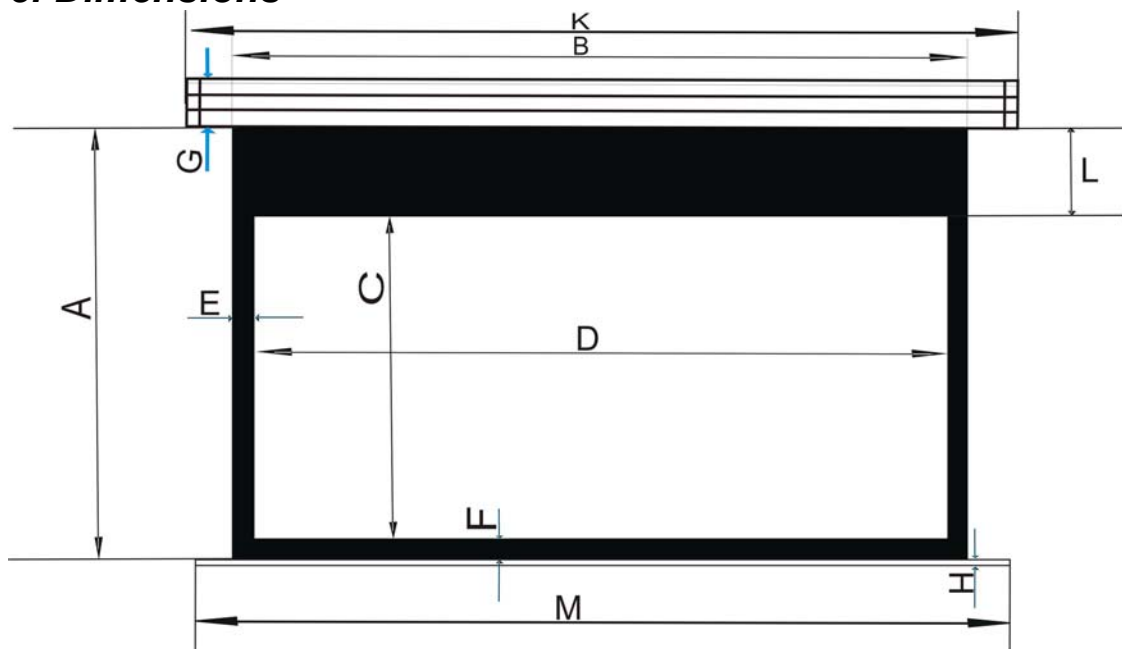

Diagonal (Viewable)	Format	A	B	C	D	L	E	F	G	H	K	M
80"	16:9	59.69	72.95	39.21	69.72	18.11	1.57	2.36	3.66	0.79	83.31	76.61
92"	16:9	65.59	83.43	45.12	80.20	18.11	1.57	2.36	3.66	0.79	93.39	78.82
100"	16:9	69.49	90.39	49.02	87.17	18.11	1.57	2.36	3.66	0.79	100.31	93.62
106"	16:9	72.44	95.55	51.97	92.40	18.11	1.57	2.36	3.66	0.79	105.79	99.09
120"	16:9	79.33	107.83	58.82	104.61	18.11	1.57	2.36	3.66	0.79	117.95	111.26
80"	4:3	68.46	67.24	47.99	64.02	18.11	1.57	2.36	3.66	0.79	77.32	70.63
90"	4:3	74.49	75.24	54.02	72.01	18.11	1.57	2.36	3.66	0.79	85.35	78.66
100"	4:3	80.47	83.23	60.00	80.00	18.11	1.57	2.36	3.66	0.79	93.39	86.69
110"	4:3	86.46	91.14	65.98	87.99	18.11	1.57	2.36	3.66	0.79	101.38	94.69
120"	4:3	89.33	95.98	68.86	92.83	18.11	1.57	2.36	3.66	0.79	105.79	99.09
130"	4:3	98.43	107.09	77.95	103.94	18.11	1.57	2.36	3.66	0.79	117.95	111.26